

AUSMALBILD

Colouring picture



Rette die rote
Katze!
Save the red cat!

AUSMALBILD

Colouring picture

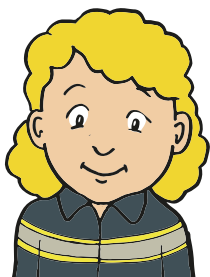

Welche Farben hat
ein Feuerwehrauto?

What colours is a
fire engine?

AUSMALBILD

Colouring picture

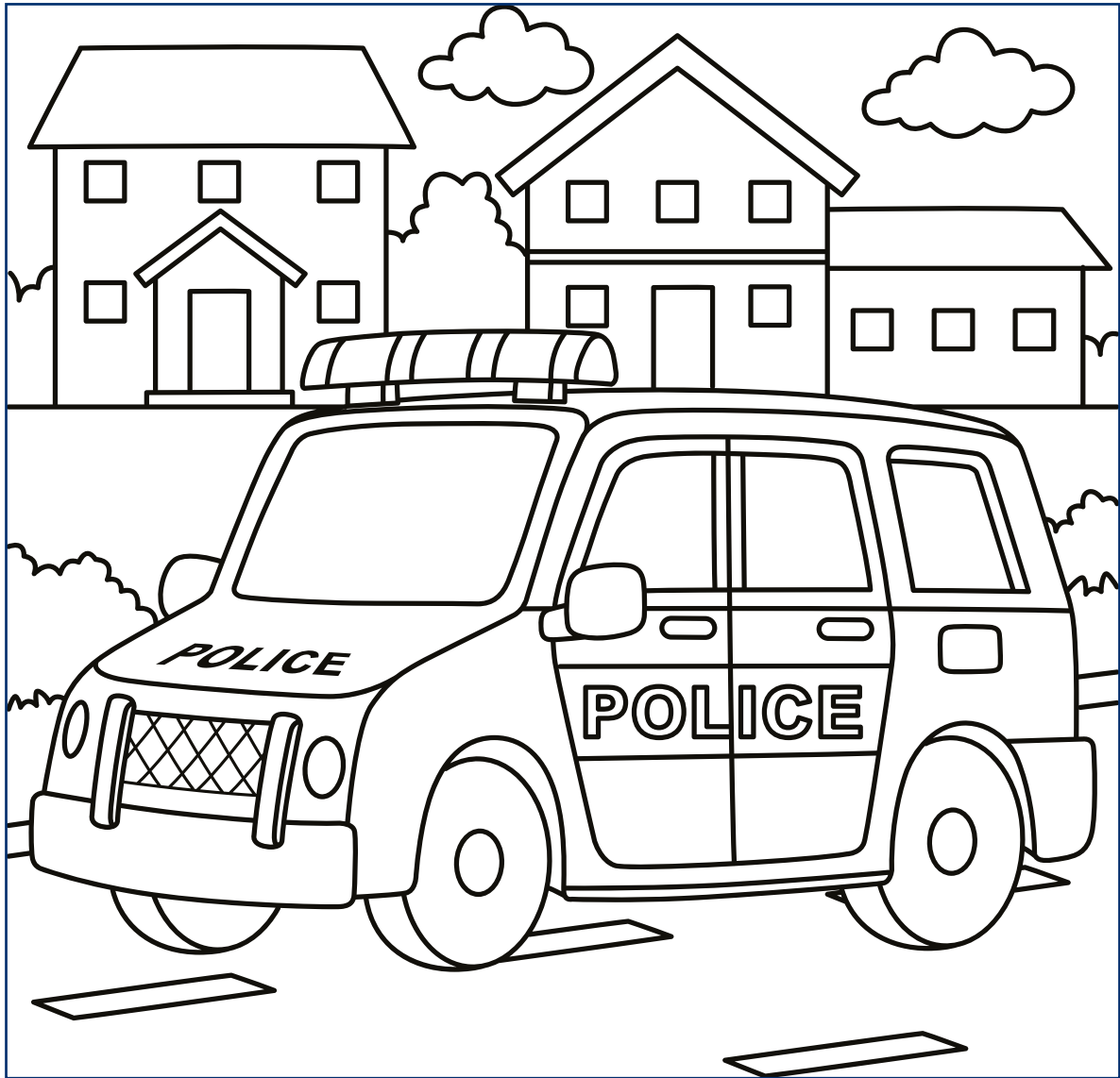

Welche Farben
hat ein Polizeiauto?
What colours is
police car?

AUSMALBILD

Colouring picture

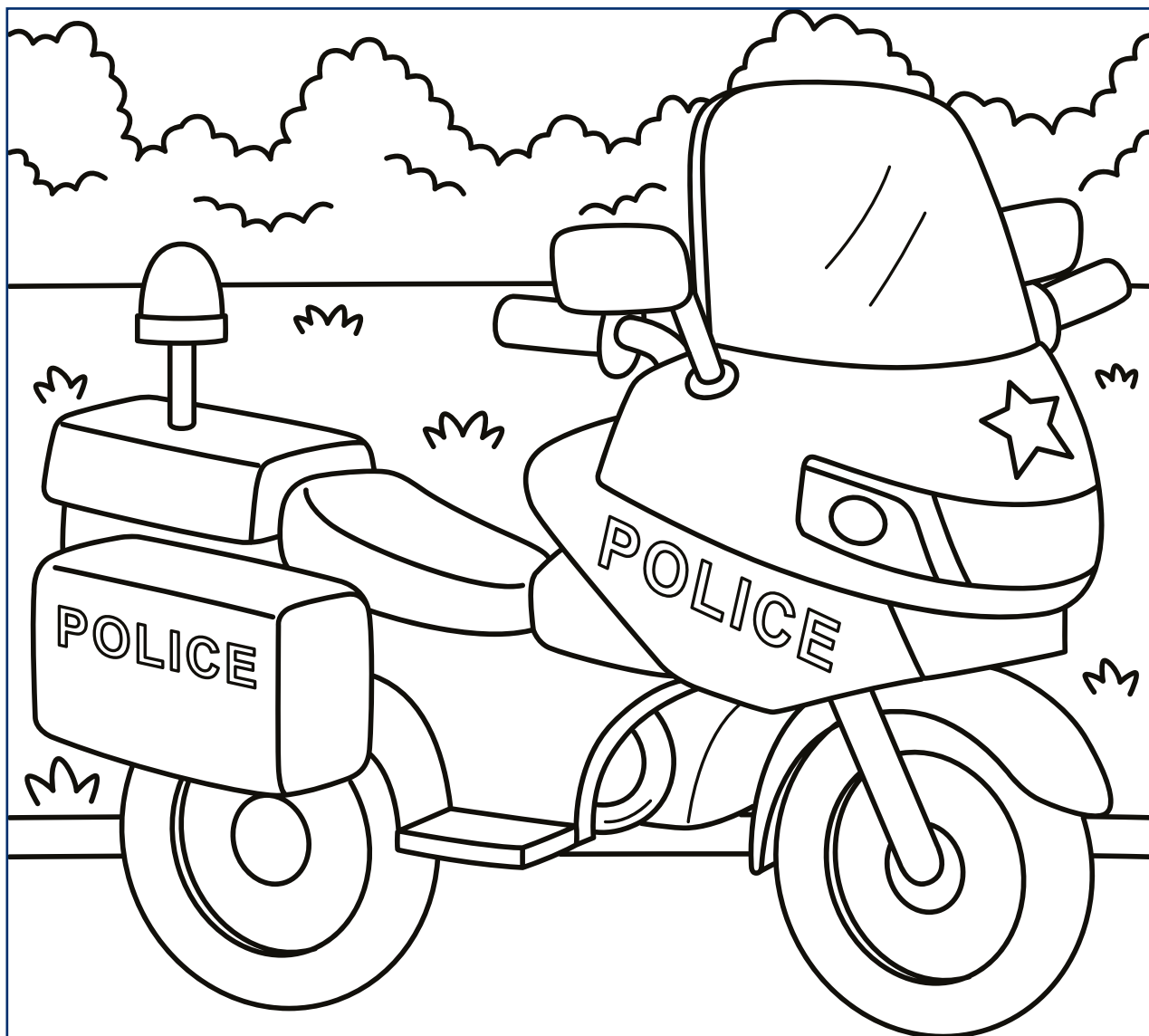

Wie sieht dein
Polizeimotorrad aus?
What colours does your
police motorcycle
have?

Seite | Page: 4

RÄTSELSPASS IM LABYRINTH

Puzzle fun in the labyrinth

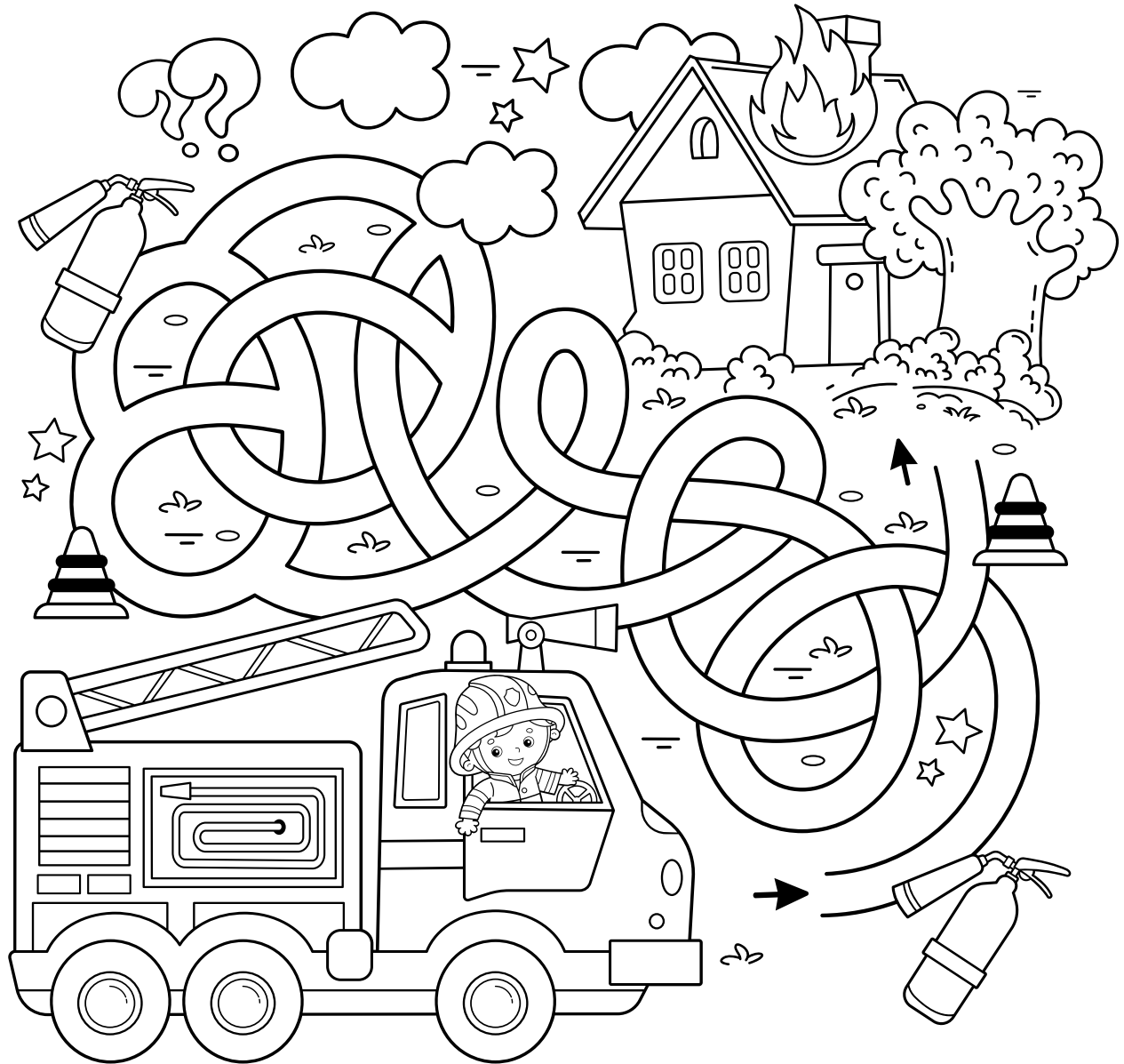

Finde schnell den Weg
zum brennenden Haus!
Quickly find your path
to the burning house!

RÄTSELSPASS IM LABYRINTH

Puzzle fun in the labyrinth

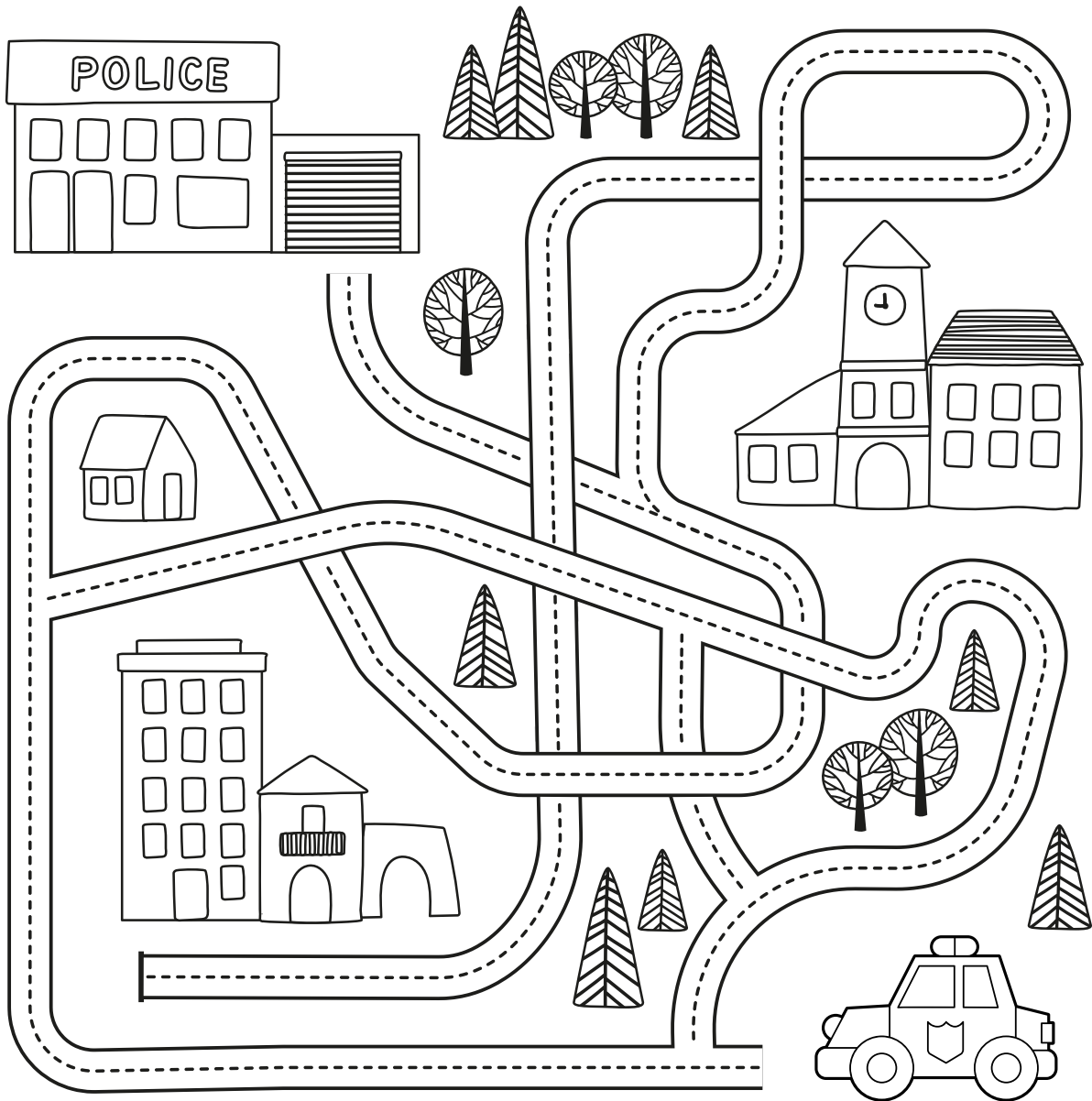

Finde den richtigen Weg
zur Polizei Station!

Find the right path to
the police station!

RÄTSELSPASS IM LABYRINTH

Puzzle fun in the labyrinth

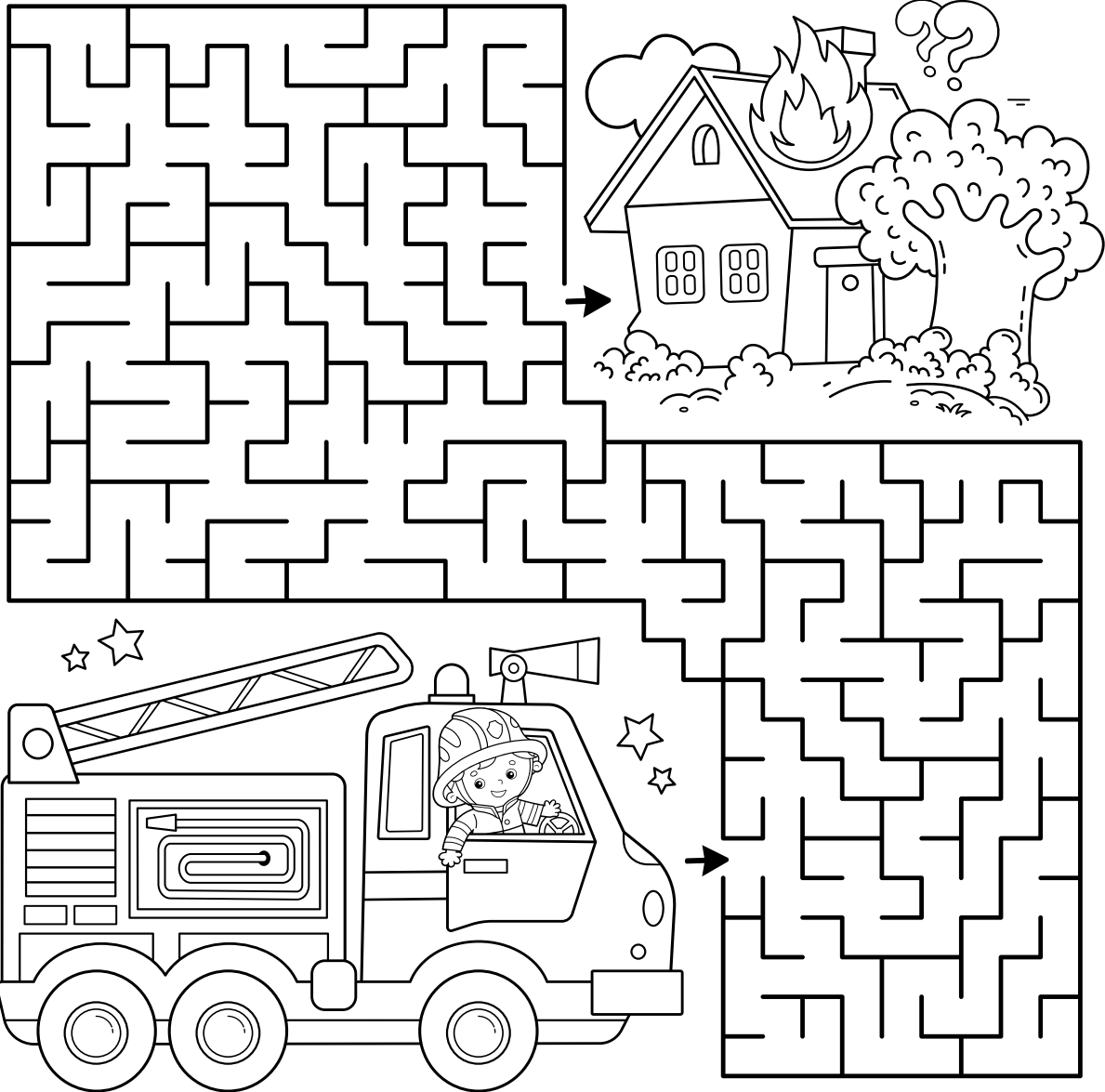

Finde schnell den Weg
zum brennenden Haus!
Quickly find your path
to the burning house!

RÄTSELSPASS IM LABYRINTH

Puzzle fun in the labyrinth

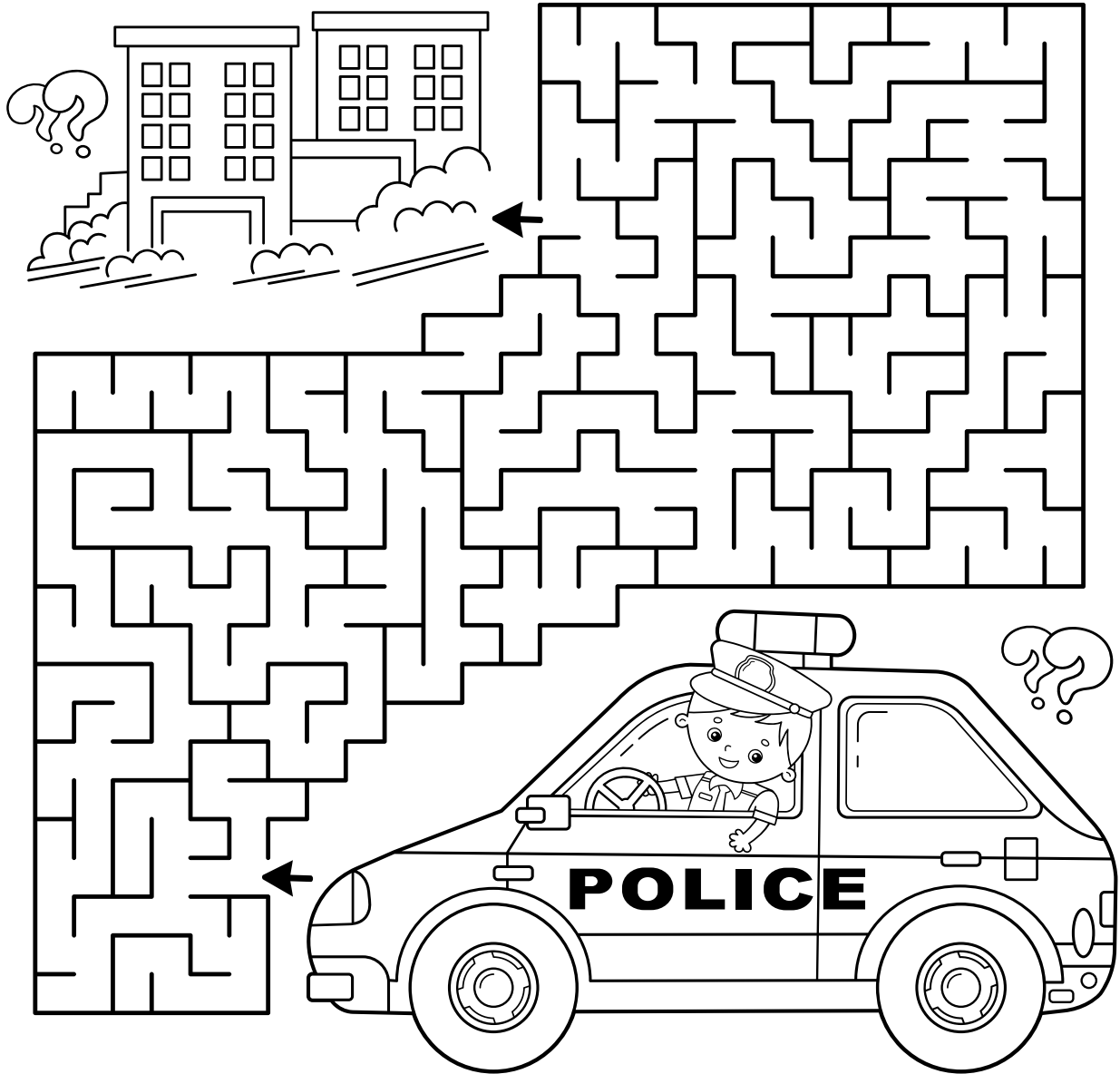

Finde den richtigen Weg
zur Polizei Station!

Find the right path to
the police station!

SUCHBILD

Search picture



Finde 7 Unterschiede
im unteren Bild
Find 7 differences in
the picture below!



SUCHBILD

Search picture



Finde 7 Unterschiede
im unteren Bild
Find 7 differences in
the picture below!

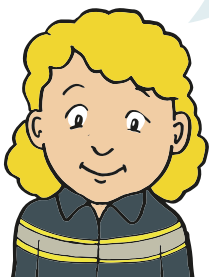

ZAHLEN VERBINDEN

Connect numbers

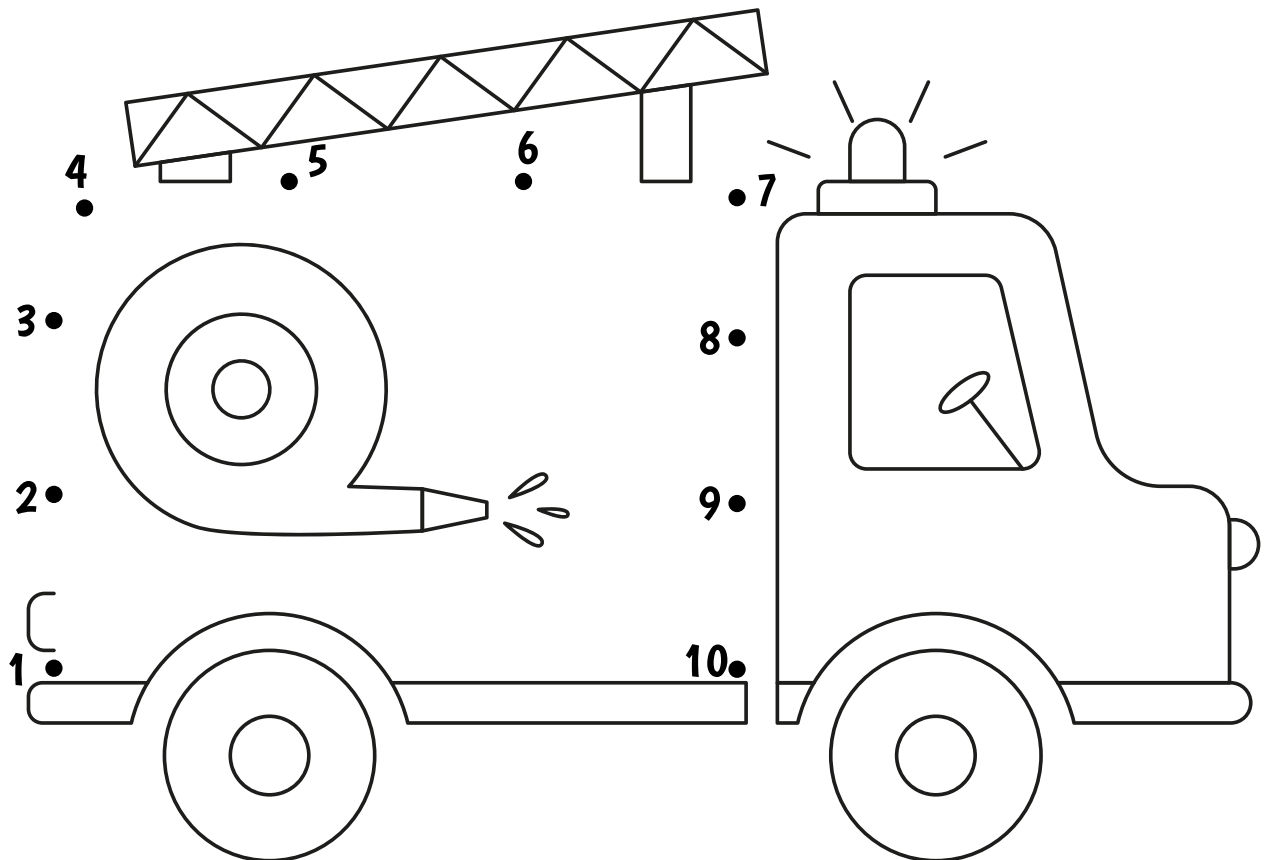

Verbinde die Zahlen
von 1 bis 10.
Connect the numbers
from 1 to 10.

ZAHLEN VERBINDEN

Connect numbers

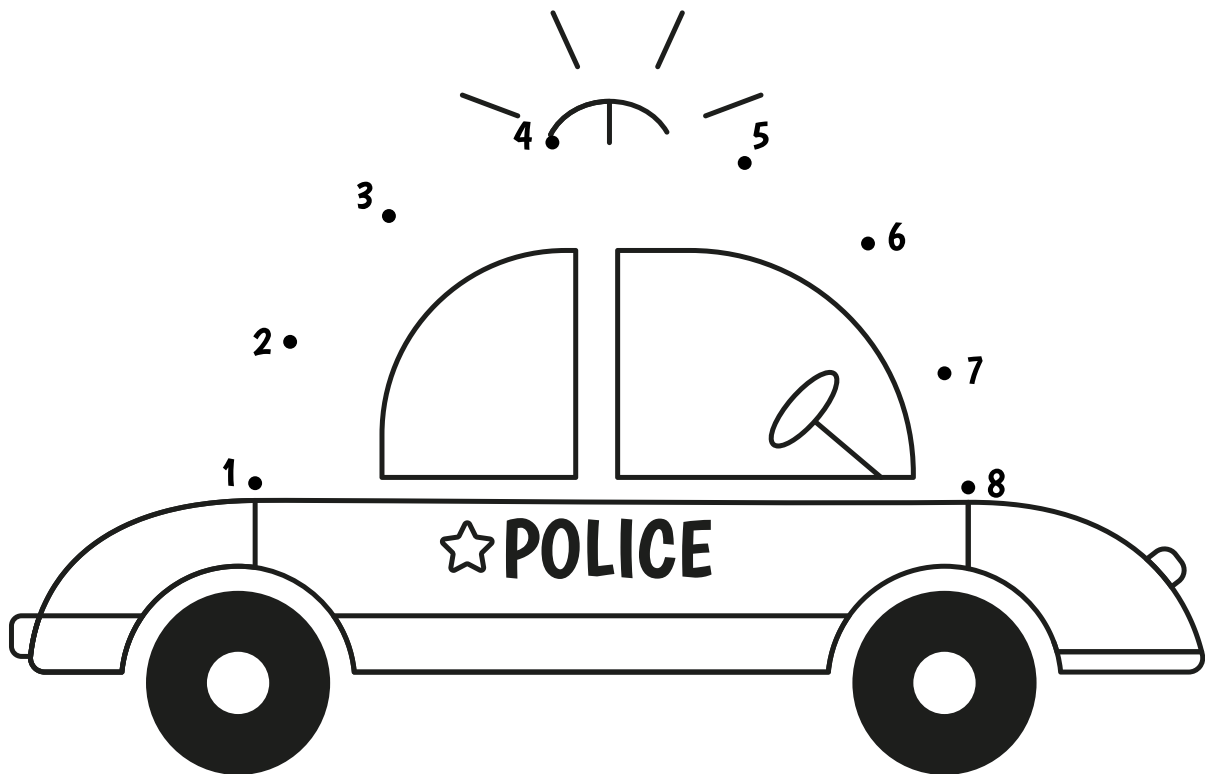

Verbinde die Zahlen
von 1 bis 8.

Connect the numbers
from 1 to 8.

LOGISCHES KOMBINIEREN

Logical combination



Schneide die
Gegenstände aus...
Cut that objects...



... und ordne sie dem
richtigen Beruf zu!
... and assign them to the
right profession!